

KOMATSU®

PC350LC-8

NET HORSEPOWER

184 kW **246 HP** @ 1950 rpm

OPERATING WEIGHT

35091–35851 kg

77,362–79,037 lb

BUCKET CAPACITY

0.68–1.96 m³ **0.89–2.56 yd³**

PC
350
LC



HYDRAULIC EXCAVATOR

Photo may include optional equipment.

WALK-AROUND

Productivity Features

● **High Production and Low Fuel Consumption**

Powerful working performance and fuel efficiency increase production and lower fuel costs.

● **Large Drawbar Pull**

provides excellent steering and slope climbing performance.

● **Higher Lifting Capacity**

Lifting mode is provided for increased lifting operation.

● **Large Digging Force**

Pressing the Power Max function button temporarily increases digging force by 8%.

● **Multi-Function Color Monitor**

- Working mode selection
- Self-diagnostic with EMMS
- Attachment hydraulic oil flow adjustment in cab

● **Automatic Three Speed Travel**

● **General Features**

- Operator Protective Guard (OPG) top guard Level 2 capable
- Engine neutral start with lock lever
- Slip-resistant plates for improved foot grip
- New cab design for hydraulic excavators
- Pattern change valve is standard

Easy Maintenance

- Extended replacement interval of engine oil, engine oil filter, and hydraulic filter
- Equipped with 10 micron fuel pre-filter as standard (with water separator)
- Side-by-side cooling concept enables individual cooling modules to be serviced
- Equipped with the EMMS monitoring system
- Easy access to engine oil filter and fuel drain valve
- Large fuel tank capacity
- Equipped with KOMTRAX[®] (standard)



KOMTRAX[®]

KOMTRAX equipped machines can send location, SMR and operation maps to a secure website utilizing wireless technology. Machines also relay error codes, cautions, maintenance items, fuel levels, and much more.

Ecology and Economy Features

- Low emission engine
- A powerful turbocharged and air-to-air aftercooled Komatsu SAA6D114E-3 engine provides 184 kW **246 HP** (net). This engine is EPA Tier 3 and EU stage 3A emissions certified without sacrificing power or machine productivity.
- Economy mode reduces fuel consumption
- Low operation noise

Large Comfortable Cab

- Low-noise cab design
- Low vibration with cab damper mounting
- Highly pressurized cab with automatic air conditioner
- Operator seat and console with armrest enables adjustment to the proper operational position

Excellent Reliability and Durability

- High rigidity work equipment
- Heavy duty boom assembly
- Sturdy frame structure
- Reliable Komatsu manufactured major components
- Highly reliable electronic devices

Large TFT LCD Monitor

- Large, easy-to-use, 7" multi-color monitor
- Can be displayed in ten languages for global support

TFT: Thin Film Transistor
LCD: Liquid Crystal Display



Photo may include optional equipment.

NET HORSEPOWER
184 kW **246 HP** @ 1950 rpm

OPERATING WEIGHT
35091 – 35851 kg
77,362 – 79,037 lb

BUCKET CAPACITY
0.68 – 1.96 m³
0.89 – 2.56 yd³

PRODUCTIVITY FEATURES



Komatsu's new "ecot3" engines are designed to deliver optimum performance under the toughest of conditions, while meeting the latest environmental regulations. This engine is EPA Tier 3 and EU Stage 3A emissions certified; "ecot3" - ecology and economy combined with Komatsu technology to create a high performance engine without sacrificing power or productivity.

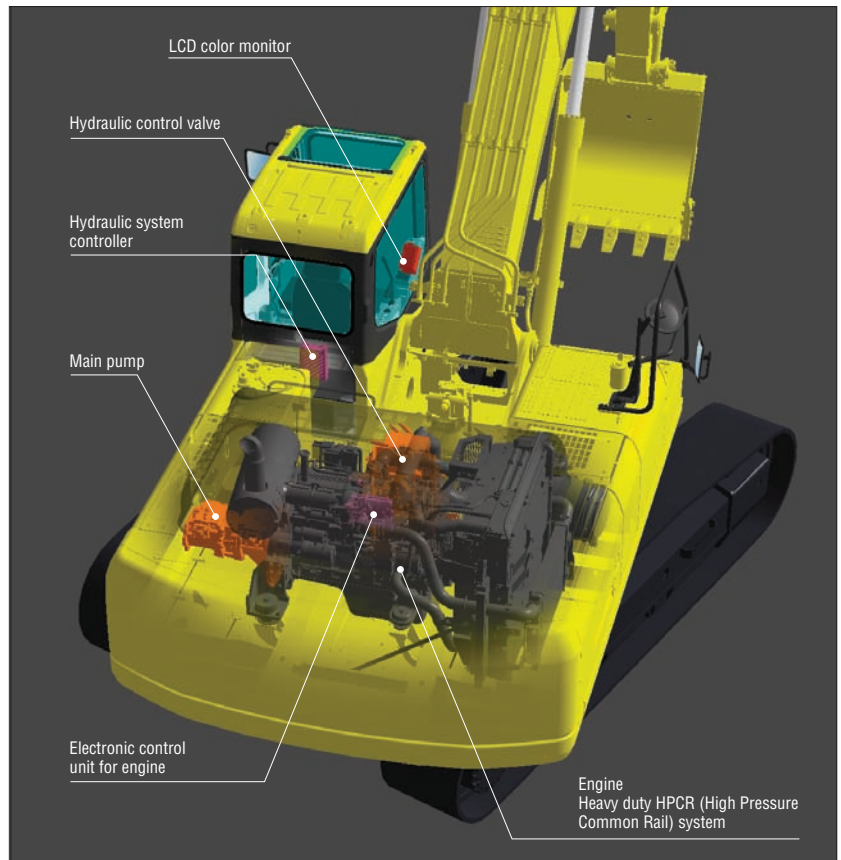

Environment-Friendly Clean Engine

The PC350LC-8 gets its exceptional power and work capacity from a Komatsu SAA6D114E-3 engine. Net output is 184 kW **246 HP**, providing increased hydraulic power and improved fuel efficiency.

The Komatsu SAA6D114E-3 is EPA Tier 3 and EU stage 3A emissions certified with NOx emission reduced by 33%. The SAA6D114E-3 engine adopts the electronically controlled Heavy Duty HPCR* fuel injection system.

*HPCR: High Pressure Common Rail

Hydraulics

Unique two-pump system ensures smooth compound movement of the work equipment. HydrauMind controls both pumps for efficient engine power use. This system also reduces hydraulic loss during operation.

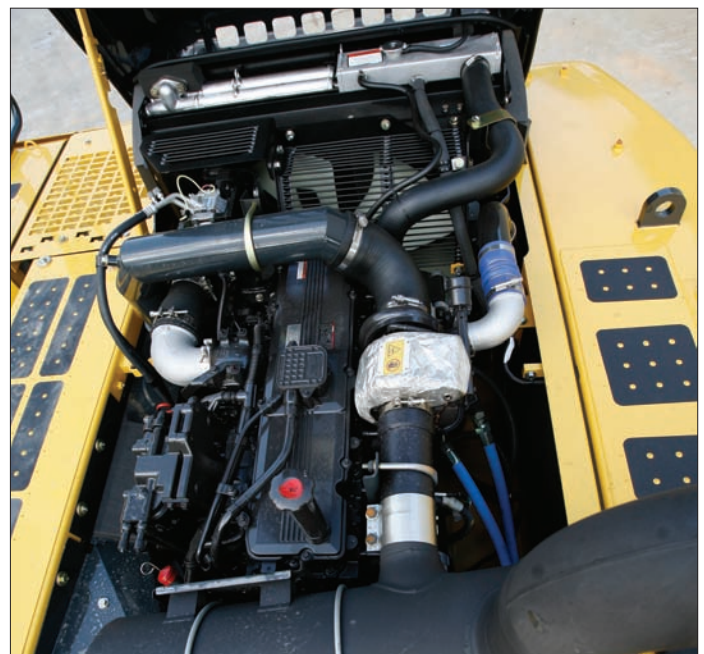

Large Maximum Drawbar Pull

Large maximum drawbar pull provides superb steering and slope climbing performance.

Maximum drawbar pull: 264 kN 26900 kgf **59,300 lb**

Large Digging Force

With the one-touch Power Max function, digging force is further increased (8.5 seconds of operation).

Maximum arm crowd force (ISO):

160 kN (16.3t) ➔ **171 kN (17.4t) 7% UP**
with Power Max.

Maximum bucket digging force (ISO):

212 kN (21.6t) ➔ **227 kN (23.1t) 7% UP**
with Power Max.

*Measured with Power Max function, 3185 mm 10'5" arm and ISO rating.

Smooth Loading Operation

Two return hoses improve hydraulic performance. In the arm out function, a portion of the oil is returned directly to the tank for smooth operation.



Two Boom Settings

Smooth mode provides easy operation for fine work or scraping down operation. When maximum digging force is needed, switch to Power mode for more effective excavating.

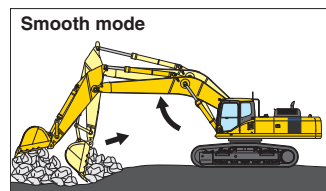

Smooth mode
Boom floats upward, reducing lifting of machine front. This facilitates fine work and scraping down operations.

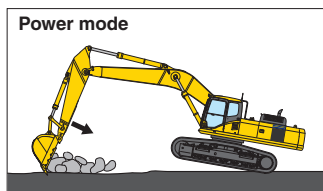

Power mode
Boom force is at maximum for normal production digging.

Automatic Three-Speed Travel

Travel speed is automatically shifted from high to low speed according to the pressure demand on the travel circuit.

Working Mode Selection

The PC350LC-8 excavator is equipped with five working modes (P, E, L, B, and ATT mode). Each mode is designed to match engine speed, pump flow, and system pressure with the current application. This provides the flexibility to match equipment performance to the job at hand.

Working Mode	Application	Advantage
P	Power mode	<ul style="list-style-type: none"> Maximum production/power Fast cycle times
E	Economy mode	<ul style="list-style-type: none"> Excellent fuel economy
L	Lifting mode	<ul style="list-style-type: none"> Hydraulic pressure is increased by 7%
B	Breaker mode	<ul style="list-style-type: none"> Optimum engine rpm, hydraulic flow, 1-way
ATT	Attachment mode	<ul style="list-style-type: none"> Optimum engine rpm, hydraulic flow, 2-way

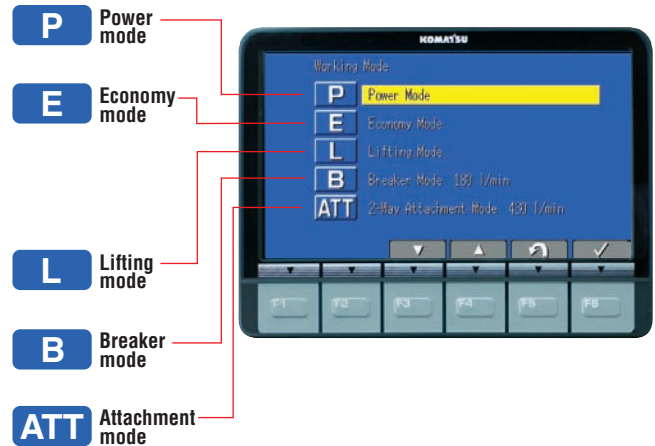

Power/Economy Modes

The PC350LC-8 offers two operator selectable working modes: Power mode for severe or high production applications and Economy mode allows significant fuel savings at slightly reduced production levels.

Lifting Mode

When the lifting mode is selected, lifting capacity is increased 7% by raising hydraulic pressure.

WORKING ENVIRONMENT



Low Noise Cab

The newly-designed cab is highly rigid and has excellent sound absorption ability. Through improvement of noise source reduction and use of a low noise engine, hydraulic equipment, and air conditioner, this machine generates a low level of noise similar to that of a modern automobile.

Low Vibration with Cab Damper Mounting

PC350LC-8 uses a multi-layer viscous mount system that incorporates a longer stroke and the addition of a spring. The new cab damper mounting combined with a high rigidity deck aids vibration reduction at the operator seat.

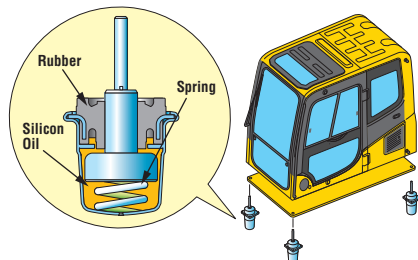

Wide Newly-Designed Cab

Newly-designed wide spacious cab includes high-back seat with reclining backrest. The seat height and longitudinal inclination are easily adjusted using a pull-up lever. You can set the appropriate operational posture of the armrest together with the console. Reclining the seat further enables you to place it into the fully flat state with the headrest attached.



Pressurized Cab

Automatic air conditioner, air filter, and a higher internal air pressure (+6.0 mm Aq +0.2" Aq) help minimize external dust from entering the cab.

Automatic Air Conditioner

Enables you to easily and precisely set cab atmosphere with the simple touch pad controls on the large LCD. The bi-level control function improves air flow and keeps the operator comfortable throughout the year. Defroster function keeps the cab glass clear.



GENERAL FEATURES

New Cab Design for Hydraulic Excavators

The cab is designed specifically for hydraulic excavators and gains reinforced strength from the pipe-structured framework. The cab framework provides high durability and impact resistance with very high impact absorbency.



Operator Protective Guard (OPG) Level 2 Top Guard (optional)

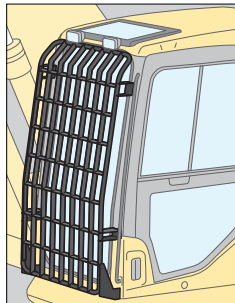

Front Full Guard Level 2 (optional)

Increased Cab Glass Area

Highly rigid cab allows for increased glass area and provides wide visibility of the work area.

Skylight

Skylight can be opened to improve overhead visibility.



Slip-Resistant Plates

Highly durable slip-resistant plates maintain excellent foot traction performance for the long term.



Lock Lever

Makes all hydraulic cab controls inoperable when placed in lock position. Neutral start function allows the machine to be started only in the lock position.



Lock Lever in Lock Position

Large Side-View Mirrors

Large left-side mirror with the addition of right-side mirrors allow the operator to see both sides of the machine.



Thermal and Fan Guards

Guarding is placed around high-temperature parts of the engine and fan drive.



Large Serrated Steps



Handrail



MAINTENANCE FEATURES

Self-Diagnostic Monitor

The PC350LC-8 features the most advanced diagnostics system in the industry. The Komatsu-exclusive system identifies maintenance items, reduces diagnostic times, indicates oil and filter replacement hours, and displays error codes.

Continuous Machine Monitoring System

When the starting switch is turned ON, check-before-starting items and caution items appear on the LCD. If abnormalities are found, a warning lamp blinks and a warning buzzer sounds. The continuous machine condition checks help prevent the development of serious problems and allow the operator to concentrate on the work at hand.

Easy Maintenance

Komatsu designed the PC350LC-8 to have easy service access. We know by doing this, routine maintenance and servicing are more likely to be performed, which can mean a reduction in costly downtime later on. Here are some of the many service features found on the PC350LC-8.

Easy Radiator Cleaning

Since the radiator and oil cooler are side-by-side modules, it is easy to clean, remove, and install them.

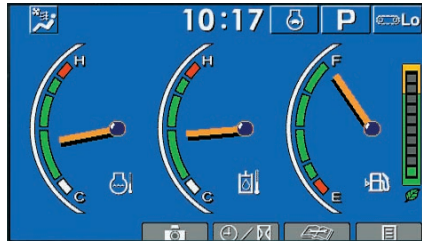

Normal display

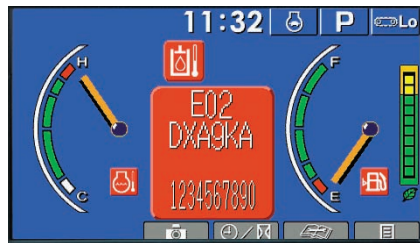

Error code display

Abnormalities Display with Code

When an abnormality occurs during operation, a user code is displayed. When an important user code is displayed, a caution lamp blinks and a warning buzzer sounds to alert the operator to take action.

Easy Access to Engine Oil filter and Fuel Drain Valve

Engine oil level check, oil fill port, and fuel filter are one side mounted to improve accessibility. Engine oil filter and fuel drain valve are remotely mounted to improve accessibility.



EMMS

Equipment Management Monitoring System



Maintenance time display

Oil Maintenance Function

When the machine exceeds the oil or filter replacement time, the oil maintenance monitor will display lights to inform the operator.

Trouble Data Memory Function

The monitor stores a record of abnormalities for effective troubleshooting.



Engine Oil Filter



Fuel Drain Valve

Equipped with Fuel Pre-Filter (with Water Separator)

Removes water and contaminants in the fuel to help prevent fuel problems.



Equipped with the Eco-Drain Valve as Standard

Enables easier and cleaner engine oil changes.

Maintenance Cost Reduction

Extended Replacement Intervals for Hydraulic Oil and Filter/Engine Oil and Filter

High performance filters are used in the hydraulic circuit and engine. By increasing the hydraulic oil, hydraulic oil filter, engine oil, and engine oil filter replacement intervals, maintenance costs are significantly reduced.



Engine oil & Engine oil filter	every 500 hours
Hydraulic oil	every 5000 hours
Hydraulic oil filter	every 1000 hours

Extended Work Equipment Greasing Interval

High quality BMRC bushings and resin shims are installed in the work equipment, excluding the bucket, which can extend the greasing interval to 500 hours.

High-Capacity Air Cleaner

High capacity air cleaner is comparable to that of larger machines. The large air cleaner extends filter element life and service intervals.



High-Pressure In-Line Filters

The PC350LC-8 has high pressure in-line filters installed at the pump discharge ports. This provides an additional level of hydraulic system protection.

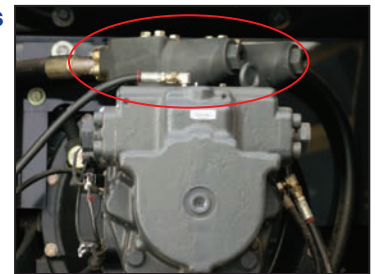
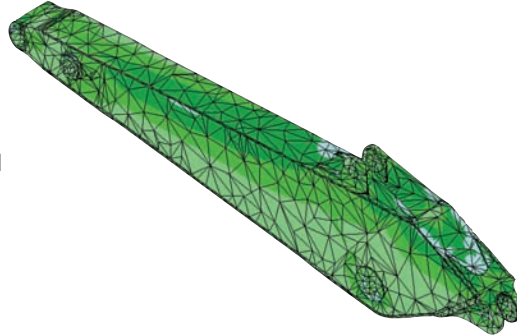

Photo may include optional equipment.

RELIABILITY FEATURES

High Rigidity Work Equipment

Thanks to large cross-sectional structures, thick high tensile strength steel, and partition walls, the boom and arm exhibit excellent durability and are highly resistant to bending and torsional stress. An HD boom assembly is offered for increased strength and reliability.



Sturdy Frame Structure

The revolving frame, center frame, and undercarriage are designed using the most advanced three-dimensional CAD and FEM analysis technology.

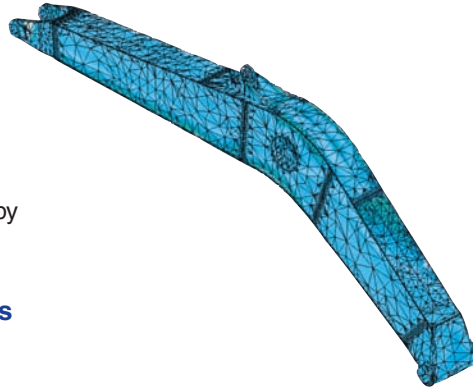

Reliable Components

All of the major machine components, such as engine, hydraulic pumps, hydraulic motors, and control valves are exclusively designed and manufactured by Komatsu.

Highly Reliable Electronic Devices

Exclusively designed electronic devices have passed severe testing.

- Controllers
- Sensors
- Connectors
- Wiring

Metal guard rings protect all the hydraulic cylinders and improve reliability.

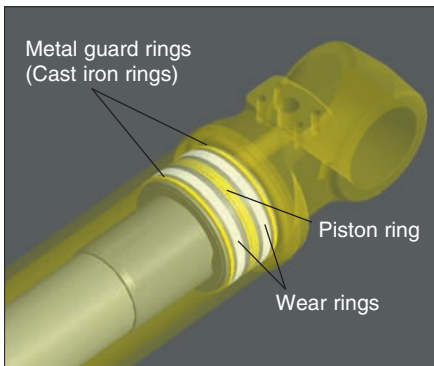

DT-Type Electrical Connectors

DT-type connectors seal tight and have high reliability.

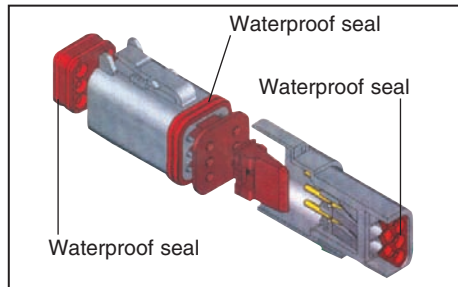

O-Ring Face Seals

Hydraulic hoses are equipped with O-ring seals versus conventional taper seal, to provide extended leak-free life.

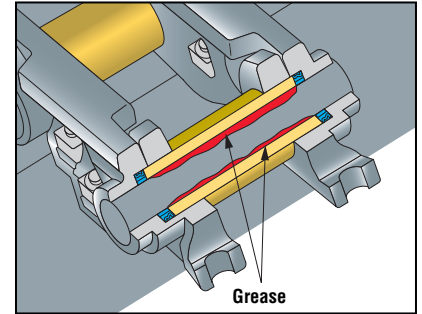

Grease Sealed Track

PC350LC-8 uses grease sealed tracks for extended undercarriage life.

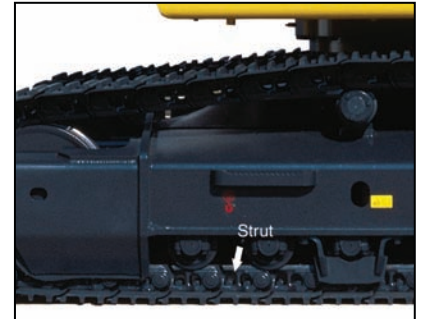

Track Link with Strut

PC350LC-8 uses track links with a strut providing superb durability.

Large LCD Color Monitor

Large Multi-Lingual LCD Monitor

A large user-friendly color monitor enables accurate and smooth work. Improved screen visibility is achieved by use of a TFT liquid crystal display that can easily be read at various angles and lighting conditions. All switches are simple and easy to operate. Industry-first function keys facilitate multi-function operations. Displays data in 10 languages to support operators around the world.



Indicators

- 1 Auto-decelerator
- 2 Working mode
- 3 Travel speed
- 4 Engine water temperature gauge
- 5 Hydraulic oil temperature gauge
- 6 Fuel gauge
- 7 Eco-gauge
- 8 Function switches menu

Basic operation switches

- 1 Auto-decelerator
- 2 Working mode selector
- 3 Travel speed selector
- 4 Buzzer cancel
- 5 Wiper
- 6 Windshield washer

Rearview Camera Display

On the large LCD color monitor, the operator can access and view one standard video camera that will display areas directly behind the machine. An optional two-camera system is available.



Equipment Management Monitoring System (EMMS)

Monitor Function

The controller monitors engine oil level, coolant temperature, battery charge, air filter clogging, etc. If the controller finds any abnormality, it is displayed on the LCD.



PC350LC-8 HYDRAULIC EXCAVATOR

SPECIFICATIONS



ENGINE

Model Komatsu SAA6D114E-3
 Type Water-cooled, 4-cycle, direct injection
 Aspiration Turbocharged and aftercooled
 Number of cylinders 6
 Bore 114 mm **4.49"**
 Stroke 135 mm **5.31"**
 Piston displacement 8.27 ltr **505 in³**
 Horsepower
 SAE J1995 Gross 194 kW **260 HP**
 ISO 9249/SAE J1349 Net 184 kW **246 HP**
 Rated rpm 1950 rpm
 Fan drive type Mechanical
 Governor All-speed, electronic
 EPA Tier 3 and EU Stage 3A emission certified.



HYDRAULIC SYSTEM

Type HydraMind (Hydraulic Mechanical Intelligence New Design) system, closed-center with load sensing and pressure compensated valves
 Number of selectable working modes 5
 Main pump:
 Type Variable displacement piston type
 Pumps for Boom, arm, bucket, swing, and travel circuits
 Maximum flow 535 ltr/min **141 U.S. gal/min**
 Supply for control circuit Self-reducing valve
 Hydraulic motors:
 Travel 2 x axial piston motors with parking brake
 Swing 1 x axial piston motor with swing holding brake
 Relief valve setting:
 Implement circuits 37.3 MPa 380 kg/cm² **5,400 psi**
 Travel circuit 37.3 MPa 380 kg/cm² **5,400 psi**
 Swing circuit 27.9 MPa 285 kg/cm² **4,050 psi**
 Pilot circuit 3.2 MPa 33 kg/cm² **470 psi**

Hydraulic cylinders:
 Number of cylinders—bore x stroke x rod diameter
 Boom 2 – 140 mm x 1480 mm x 100 mm **5.5" x 58.3" x 3.9"**
 Arm 1 – 160 mm x 1825 mm x 110 mm **6.3" x 71.9" x 4.3"**
 Bucket for 3.2 m **10'5"** and 4.0 m **13'2"** Arms
 1-140 mm x 1285 mm x 100 mm **5.5" x 50.6" x 3.9"**
 for 2.54 m **8'4"** Arm
 1-150 mm x 1285 mm x 110 mm **5.9" x 50.6" x 4.3"**



DRIVES AND BRAKES

Steering control Two levers with pedals
 Drive method Hydrostatic
 Maximum drawbar pull 264 kN 26900 kg **59,300 lb**
 Gradeability 70%, 35°
 Maximum travel speed: High 5.5 km/h **3.4 mph**
 (Auto-shift) Mid 4.5 km/h **2.8 mph**
 Low 3.2 km/h **2.0 mph**
 Service brake Hydraulic lock
 Parking brake Mechanical disc brake



SWING SYSTEM

Drive method Hydrostatic
 Swing reduction Planetary gear
 Swing circle lubrication Grease bathed
 Service brake Hydraulic lock
 Holding brake/Swing lock Mechanical disc brake
 Swing speed 9.5 rpm
 Swing torque 11386 kg•m **82,313 ft. lbs.**



UNDERCARRIAGE

Center frame X-frame
 Track frame Box-section
 Track type Sealed
 Track adjuster Hydraulic
 No. of shoes 48 each side
 No. of carrier rollers 2 each side
 No. of track rollers 8 each side



COOLANT AND LUBRICANT CAPACITY (REFILLING)

Fuel tank 605 ltr **160 U.S. gal**
 Coolant 30.3 ltr **8.0 U.S. gal**
 Engine 35.0 ltr **9.2 U.S. gal**
 Final drive, each side 8.5 ltr **2.2 U.S. gal**
 Swing drive 13.4 ltr **3.5 U.S. gal**
 Hydraulic tank 188 ltr **49.7 U.S. gal**



OPERATING WEIGHT (APPROXIMATE)

Operating weight, including 6500 mm **21'3"** one-piece HD boom, 3185 mm **10'5"** arm, SAE heaped 1.96 m³ **2.56 yd³** bucket, rated capacity of lubricants, coolant, full fuel tank, operator, and standard equipment.

Triple-Grouser Shoes	Operating Weight	Ground Pressure
700 mm 28"	35091 kg 77,362 lb	0.58 kg/cm ² 8.22 psi
800 mm 31.5"	35471 kg 78,200 lb	0.51 kg/cm ² 7.32 psi
850 mm 33.5"	35851 kg 79,037 lb	0.49 kg/cm ² 6.92 psi



WORKING FORCES

	Arm	2540 mm 8'4"	3185 mm 10'5"	4020 mm 13'2"
SAE rating	Bucket digging force at power max.	23300 kgf 51,370 lb	20400 kgf 44,970 lb	20400 kgf 44,970 lb
	Arm crowd force at power max.	19700 kgf 43,430 lb	16800 kgf 37,040 lb	14200 kgf 31,310 lb
ISO rating	Bucket digging force at power max.	26400 kgf 58,200 lb	23100 kgf 50,930 lb	23100 kgf 50,930 lb
	Arm crowd force at power max.	20500 kgf 45,190 lb	17400 kgf 38,360 lb	14700 kgf 32,410 lb



DIMENSIONS

	Arm Length	2540 mm 8'4"	3185 mm 10'5"	4020 mm 13'2"
A	Overall length	11180 mm 36'8"	11140 mm 36'7"	11170 mm 36'8"
B	Length on ground (transport):	6760 mm 22'2"	5930 mm 19'5"	5475 mm 18'0"
C	Overall height (to top of boom)	3410 mm 11'2"	3280 mm 10'9"	3760 mm 12'4"
D	Overall width	3440 mm 11'4"		
E	Overall height (to top of cab)	3130 mm 10'3"		
F	Ground clearance, counterweight	1185 mm 3'11"		
G	Ground clearance (minimum)	500 mm 1'8"		
H	Tail swing radius	3450 mm 11'4"		
I	Track length on ground	4030 mm 13'3"		
J	Track length	4955 mm 16'3"		
K	Track gauge	2590 mm 8'6"		
L	Width of crawler	3440 mm 11'4"		
M	Shoe width	850 mm 33.5"		
N	Grouser height	36 mm 1.4"		
O	Machine cab height	2580 mm 8'6"		
P	Machine cab width	2995 mm 9'10"		
Q	Distance, swing center to rear end	3405 mm 11'2"		

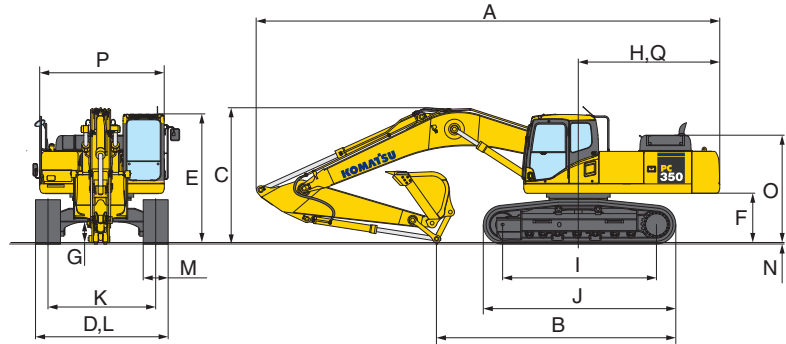

BACKHOE BUCKET, ARM, AND BOOM COMBINATION

Bucket Type	Bucket			Arms		
	Capacity	Width	Weight	2540 mm 8'4"	3185 mm 10'5"	4020 mm 13'2"
Komatsu TL	0.93 m ³ 1.21 yd³	762 mm 30"	1097 kg 2,418 lb	V	V	V
	1.18 m ³ 1.54 yd³	914 mm 36"	1198 kg 2,641 lb	V	V	V
	1.44 m ³ 1.88 yd³	1067 mm 42"	1325 kg 2,921 lb	V	V	V
	1.70 m ³ 2.22 yd³	1219 mm 48"	1426 kg 3,144 lb	V	V	W
	1.96 m ³ 2.56 yd³	1372 mm 54"	1554 kg 3,425 lb	W	W	X
Komatsu HP	0.68 m ³ 0.89 yd³	610 mm 24"	1022 kg 2,254 lb	V	V	V
	0.93 m ³ 1.21 yd³	762 mm 30"	1178 kg 2,598 lb	V	V	V
	1.18 m ³ 1.54 yd³	914 mm 36"	1358 kg 2,993 lb	V	V	V
	1.44 m ³ 1.88 yd³	1067 mm 42"	1439 kg 3,173 lb	V	V	V
	1.70 m ³ 2.22 yd³	1219 mm 48"	1555 kg 3,429 lb	V	V	X
1.96 m ³ 2.56 yd³	1372 mm 54"	1701 kg 3,750 lb	W	X	Y	
Komatsu HPS	0.68 m ³ 0.89 yd³	610 mm 24"	1112 kg 2,451 lb	V	V	V
	0.93 m ³ 1.21 yd³	762 mm 30"	1294 kg 2,853 lb	V	V	V
	1.18 m ³ 1.54 yd³	914 mm 36"	1437 kg 3,167 lb	V	V	V
	1.44 m ³ 1.88 yd³	1067 mm 42"	1607 kg 3,543 lb	V	V	W
	1.70 m ³ 2.22 yd³	1219 mm 48"	1750 kg 3,857 lb	V	W	X
1.96 m ³ 2.56 yd³	1372 mm 54"	1921 kg 4,236 lb	W	X	Y	
Komatsu HPX	0.68 m ³ 0.89 yd³	610 mm 24"	1239 kg 2,731 lb	V	V	V
	0.93 m ³ 1.21 yd³	762 mm 30"	1421 kg 3,133 lb	V	V	V
	1.18 m ³ 1.54 yd³	914 mm 36"	1564 kg 3,447 lb	V	V	V
	1.44 m ³ 1.88 yd³	1067 mm 42"	1734 kg 3,823 lb	V	V	W
	1.70 m ³ 2.22 yd³	1219 mm 48"	1877 kg 4,137 lb	V	W	X
1.96 m ³ 2.56 yd³	1372 mm 54"	2048 kg 4,516 lb	X	X	Y	

V – Used with densities up to 3,500 lb/yd³, W – Used with densities up to 3,000 lb/yd³

X – Used with densities up to 2,500 lb/yd³, Y – Used with densities up to 2,000 lb/yd³, Z – Not useable

WORKING RANGES



WORKING RANGE

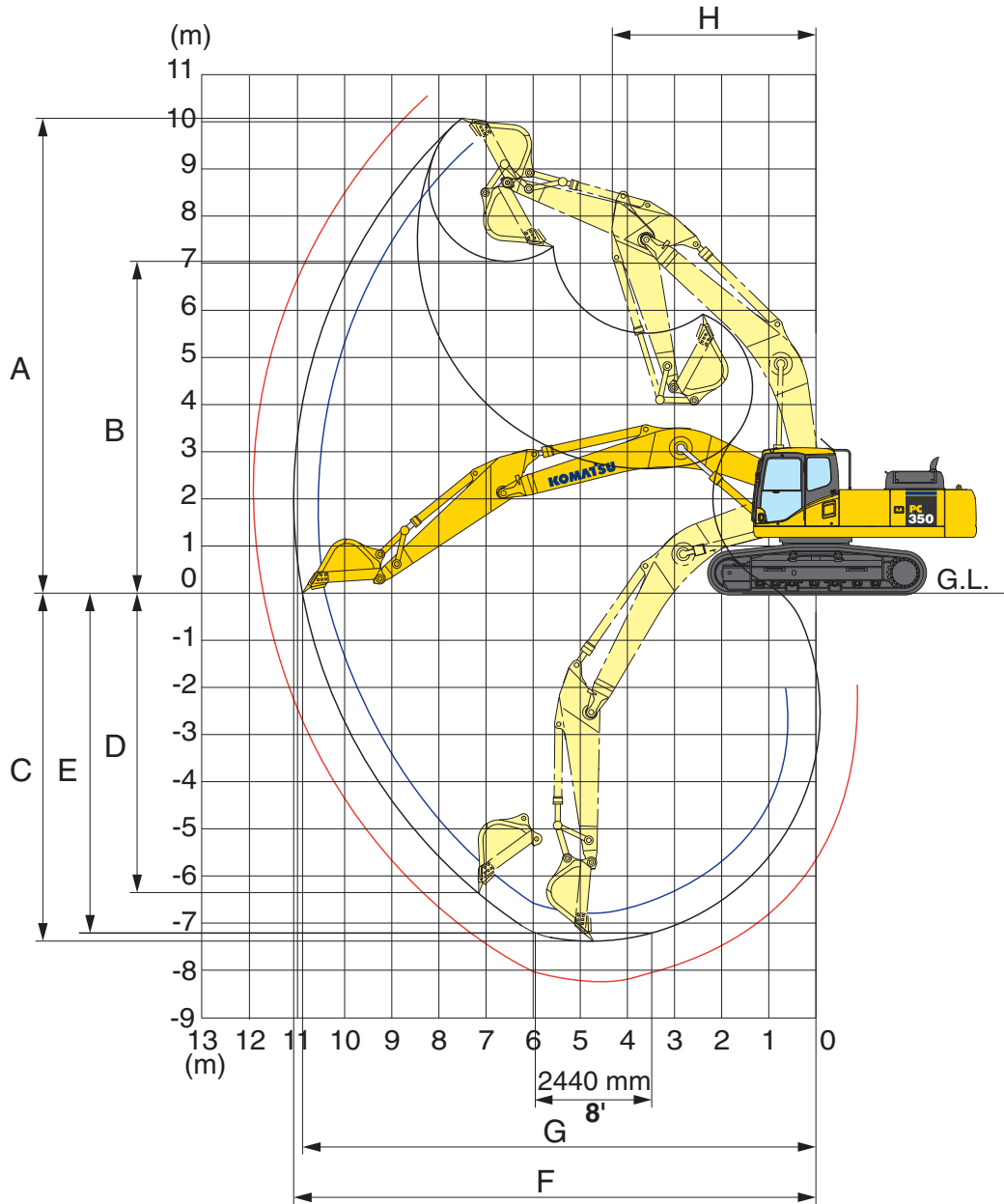

	Arm	2540 mm 8'4"	3185 mm 10'5"	4020 mm 13'2"
A	Max. digging height	9965 mm 32'8"	10210 mm 33'6"	10550 mm 34'7"
B	Max. dumping height	6895 mm 22'7"	7110 mm 23'4"	7490 mm 24'7"
C	Max. digging depth	6705 mm 22'0"	7380 mm 24'3"	8180 mm 26'10"
D	Max. vertical wall digging depth	5880 mm 19'4"	6480 mm 21'3"	7280 mm 23'11"
E	Max. digging depth of cut for 8' level	6520 mm 21'5"	7180 mm 23'7"	8045 mm 26'5"
F	Max. digging reach	10550 mm 34'7"	11100 mm 36'5"	11900 mm 39'1"
G	Max. digging reach at ground level	10355 mm 34'0"	10920 mm 35'10"	11730 mm 38'6"
H	Min. swing radius	4400 mm 14'5"	4310 mm 14'2"	4320 mm 14'2"

LIFTING CAPACITIES



LIFTING CAPACITY

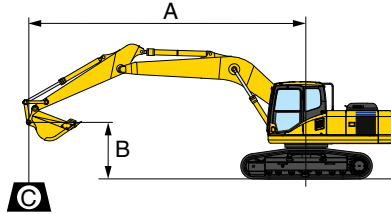

- A: Reach from swing center
- B: Bucket hook height
- C: Lifting capacity
- Cf: Rating over front
- Cs: Rating over side
- ⊗: Rating at maximum reach

Conditions:

- Arm: 2540 mm 8'4"
- Boom length: 6500 mm 21'3"
- Bucket: 1.4 m³ 1.83 yd³ (SAE heaped)
- Bucket weight: 1014 kg 2,235 lb

PC350LC-8		Shoe 800 mm 31.5"										Unit: kg/lb	
B	A MAX	3.0 m 10'		4.6 m 15'		6.1 m 20'		7.6 m 25'		9.1 m 30'		⊗ MAX	
		Cf	Cs	Cf	Cs	Cf	Cs	Cf	Cs	Cf	Cs	Cf	Cs
7.6 m 25'	7.1 m 23'											*7600 *16,800	7600 16,800
6.1 m 20'	8.1 m 26'							*7850 *17,300	6600 14,600			*7450 *16,400	5950 13,100
4.6 m 15'	8.7 m 28'			*12650 *27,800	*12650 *27,800	*9750 *21,500	9250 20,400	*8250 *18,100	6450 14,200			*7650 *16,800	5100 11,300
3.0 m 10'	9.0 m 29'			*15100 *33,300	13500 29,800	*11050 *24,400	8750 19,300	*8900 *19,700	6150 13,600	7250 16,000	4550 10,000	7450 16,400	4700 10,300
1.5 m 5'	9.0 m 30'			*15100 *33,300	12650 27,800	*12100 *26,700	8300 18,300	*9400 *20,700	5950 13,100	7150 15,700	4450 9,800	7250 16,000	4550 10,000
0 m 0'	8.8 m 29'			*16000 *35,300	12300 27,200	*12400 *27,300	8000 17,700	9300 20,500	5750 12,700	7050 15,600	4350 9,600	7450 16,500	4600 10,200
-1.5 m -5'	8.3 m 27'			*15950 *35,200	12350 27,300	*12050 *26,600	7900 17,400	9250 20,400	5700 12,600			*8100 *17,800	5050 11,100
-3.0 m -10'	7.5 m 24'	*17050 *37,600	*17050 *37,600	*14050 *31,000	12550 27,700	*10800 *23,800	8000 17,600	*7800 *17,200	5800 12,700			*8000 *17,700	5950 13,100
-4.6 m -15'	6.1 m 20'	*12800 *28,200	*12800 *28,200	*10750 *23,700	*10750 *23,700	*7900 *17,400	*7900 *17,400					*7350 *16,300	*7350 *16,300

PC350LC-8		Shoe 850 mm 33.5"										Unit: kg/lb	
B	A MAX	3.0 m 10'		4.6 m 15'		6.1 m 20'		7.6 m 25'		9.1 m 30'		⊗ MAX	
		Cf	Cs	Cf	Cs	Cf	Cs	Cf	Cs	Cf	Cs	Cf	Cs
7.6 m 25'	7.1 m 23'											*7600 *16,800	*7600 *16,800
6.1 m 20'	8.1 m 26'							*7850 *17,300	6650 14,700			*7450 *16,400	6000 13,200
4.6 m 15'	8.7 m 28'			*12650 *27,800	*12650 *27,800	*9750 *21,500	9300 20,500	*8250 *18,100	6450 14,300			*7650 *16,800	5150 11,300
3.0 m 10'	9.0 m 29'			*15100 *33,300	13600 30,000	*11050 *24,400	8800 19,400	*8900 *19,700	6200 13,700	7300 16,100	4600 10,100	7500 16,500	4700 10,400
1.5 m 5'	9.0 m 30'			*15100 *33,300	12700 28,000	*12100 *26,700	8350 18,400	*9400 *20,700	5950 13,100	7200 15,800	4450 9,900	7300 16,100	4550 10,000
0 m 0'	8.8 m 29'			*16000 *35,300	12400 27,300	*12400 *27,300	8050 17,800	9350 20,700	5800 12,800	7100 15,700	4400 9,700	7500 16,600	4650 10,300
-1.5 m -5'	8.3 m 27'			*15950 *35,200	12450 27,400	*12050 *26,600	7950 17,500	*9250 *20,400	5750 12,600			*8100 *17,800	5050 11,200
-3.0 m -10'	7.5 m 24'	*17050 *37,600	*17050 *37,600	*14050 *31,000	12600 27,800	*10800 *23,800	8050 17,700	*7800 *17,200	5800 12,800			*8000 *17,700	6000 13,200
-4.6 m -15'	6.1 m 20'	*12800 *28,200	*12800 *28,200	*10750 *23,700	*10750 *23,700	*7900 *17,400	*7900 *17,400					*7350 *16,300	*7350 *16,300

*Load is limited by hydraulic capacity rather than tipping. Ratings are based on SAE standard No. J1097. Rated loads do not exceed 87% of hydraulic lift capacity or 75% of tipping load.

PC350LC-8 HYDRAULIC EXCAVATOR

LIFTING CAPACITIES



LIFTING CAPACITY

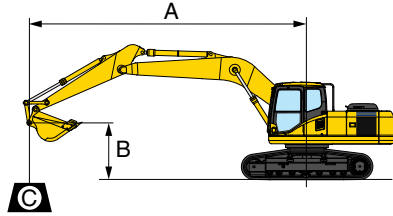

- A: Reach from swing center
- B: Bucket hook height
- C: Lifting capacity
- Cf: Rating over front
- Cs: Rating over side
- ⊗ : Rating at maximum reach

Conditions:

- Arm: 3185 mm **10'5"**
- Boom length: 6500 mm **21'3"**
- Bucket: 1.4 m³ **1.83 yd³** (SAE heaped)
- Bucket weight: 1014 kg **2,235 lb**

PC350LC-8		Shoe 700 mm 28"										Unit: kg/lb		
A	B	MAX	3.0 m 10'		4.6 m 15'		6.1 m 20'		7.6 m 25'		9.1 m 30'		⊗ MAX	
			Cf	Cs	Cf	Cs	Cf	Cs	Cf	Cs	Cf	Cs	Cf	Cs
7.6 m 25'	7.7 m 25'								*6050 *13,400	*6050 *13,400			*5350 *11,800	*5350 *11,800
6.1 m 20'	8.7 m 28'								*7200 *15,800	6700 14,700			*5250 *11,600	5250 11,600
4.6 m 15'	9.2 m 30'					*9050 *19,900	*9050 *19,900	*7700 *17,000	6500 14,300	*6850 *15,100	4650 10,300		*5350 *11,800	4550 10,100
3.0 m 10'	9.5 m 31'			*14550 *32,100	13900 30,600	*10450 *23,000	8850 19,500	*8500 *18,700	6200 13,700	7200 15,900	4550 10,000		*5700 *12,500	4200 9,300
1.5 m 5'	9.6 m 31'			*16850 *37,200	12850 28,400	*11750 *25,900	8350 18,500	*9150 *20,100	5950 13,100	7050 15,600	4400 9,700		*6250 *13,800	4050 9,000
0 m 0'	9.4 m 31'			*17200 *37,900	12350 27,200	*12350 *27,200	8000 17,700	9250 20,400	5700 12,600	6950 15,300	4300 9,500		6700 14,700	4150 9,100
-1.5 m -5'	8.9 m 29'	*9950 *21,900	*9950 *21,900	*16700 *36,800	12200 26,900	*12300 *27,100	7850 17,300	9100 20,100	5600 12,400	6900 15,200	4250 9,400		7200 15,800	4450 9,800
-3.0 m -10'	8.1 m 27'	*17800 *39,200	*17800 *39,200	*15200 *33,500	12350 27,200	*11450 *25,300	7850 17,300	*8650 *19,100	5600 12,400				*7700 *16,900	5100 11,300
-4.6 m -15'	6.9 m 23'	*16150 *35,700	*16150 *35,700	*12500 *27,600	12500 27,500	*9400 *20,800	8050 17,700						*7500 *16,500	6650 14,600
-6.1 m -20'	6.4 m 21'			*7550 *16,700	*7550 *16,700									

PC350LC-8		Shoe 800 mm 31.5"										Unit: kg/lb		
A	B	MAX	3.0 m 10'		4.6 m 15'		6.1 m 20'		7.6 m 25'		9.1 m 30'		⊗ MAX	
			Cf	Cs	Cf	Cs	Cf	Cs	Cf	Cs	Cf	Cs	Cf	Cs
7.6 m 25'	7.7 m 25'								*6050 *13,400	*6050 *13,400			*5350 *11,800	*5350 *11,800
6.1 m 20'	8.7 m 28'								*7200 *15,800	6750 14,900			*5250 *11,600	*5250 *11,600
4.6 m 15'	9.2 m 30'					*9050 *19,900	*9050 *19,900	*7700 *17,000	6550 14,400	*6850 *15,100	4750 10,400		*5350 *11,800	4600 10,200
3.0 m 10'	9.5 m 31'			*14550 *32,100	*13950 *30,700	*10450 *23,000	8950 19,700	*8500 *18,700	6250 13,800	*7300 *16,100	4600 10,200		*5700 *12,500	4250 9,400
1.5 m 5'	9.6 m 31'			*16850 *37,200	13000 28,700	*11750 *25,900	8450 18,600	*9150 *20,100	6000 13,200	7150 15,800	4450 9,800		*6250 *13,800	4100 9,100
0 m 0'	9.4 m 31'			*17200 *37,900	12450 27,500	*12350 *27,200	8100 17,900	9350 20,600	5800 12,800	7050 15,500	4350 9,600		6750 14,900	4200 9,200
-1.5 m -5'	8.9 m 29'	*9950 *21,900	*9950 *21,900	*16700 *36,800	12350 27,200	*12300 *27,100	7950 17,500	9200 20,300	5650 12,500	7000 15,400	4300 9,500		7250 16,000	4500 9,900
-3.0 m -10'	8.1 m 27'	*17800 *39,200	*17800 *39,200	*15200 *33,500	12450 27,500	*11450 *25,300	7950 17,500	*8650 *19,100	5700 12,500				*7700 *16,900	5200 11,400
-4.6 m -15'	6.9 m 23'	*16150 *35,700	*16150 *35,700	*12500 *27,600	*12500 *27,600	*9400 *20,800	8100 17,900						*7500 *16,500	6700 14,800
-6.1 m -20'	6.4 m 21'			*7550 *16,700	*7550 *16,700									

*Load is limited by hydraulic capacity rather than tipping. Ratings are based on SAE standard No. J1097. Rated loads do not exceed 87% of hydraulic lift capacity or 75% of tipping load.



LIFTING CAPACITY

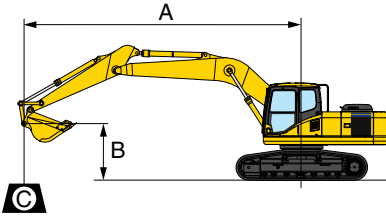

- A: Reach from swing center
- B: Bucket hook height
- C: Lifting capacity
- Cf: Rating over front
- Cs: Rating over side
- ⊗ : Rating at maximum reach

Conditions:

- Arm: 3185 mm **10'5"**
- Boom length: 6500 mm **21'3"**
- Bucket: 1.4 m³ **1.83 yd³** (SAE heaped)
- Bucket weight: 1014 kg **2,235 lb**

PC350LC-8		Shoe 850 mm 33.5"										Unit: kg/lb	
A B	MAX	3.0 m 10'		4.6 m 15'		6.1 m 20'		7.6 m 25'		9.1 m 30'		⊗ MAX	
		Cf	Cs	Cf	Cs	Cf	Cs	Cf	Cs	Cf	Cs	Cf	Cs
7.6 m 25'	7.7 m 25'							*6050 *13,400	*6050 *13,400			*5350 *11,800	*5350 *11,800
6.1 m 20'	8.7 m 28'							*7200 *15,800	6800 15,000			*5250 *11,600	*5250 *11,600
4.6 m 15'	9.2 m 30'					*9050 *19,900	*9050 *19,900	*7700 *17,000	6600 14,500	*6850 *15,100	4750 10,500	*5350 *11,800	4650 10,200
3.0 m 10'	9.5 m 31'			*14550 *32,100	*13950 *30,700	*10450 *23,000	9000 19,800	*8500 *18,700	6300 13,900	*7300 *16,100	4650 10,200	*5700 *12,500	4300 9,400
1.5 m 5'	9.6 m 31'			*16850 *37,200	13050 28,800	*11750 *25,900	8500 18,700	*9150 *20,100	6000 13,300	7200 15,900	4500 9,900	*6250 *13,800	4150 9,100
0 m 0'	9.4 m 31'			*17200 *37,900	12550 27,600	*12350 *27,200	8150 18,000	9400 20,700	5800 12,800	7100 15,600	4350 9,700	6800 15,000	4200 9,300
-1.5 m -5'	8.9 m 29'	*9950 *21,900	*9950 *21,900	*16700 *36,800	12400 27,300	*12300 *27,100	7950 17,600	9250 20,500	5700 12,600	7050 15,500	4350 9,600	7300 16,100	4500 9,900
-3.0 m -10'	8.1 m 27'	*17800 *39,200	*17800 *39,200	*15200 *33,500	12500 27,600	*11450 *25,300	8000 17,600	*8650 *19,100	5700 12,600			*7700 *16,900	5200 11,500
-4.6 m -15'	6.9 m 23'	*16150 *35,700	*16150 *35,700	*12500 *27,600	*12500 *27,600	*9400 *20,800	8150 18,000					*7500 *16,500	6750 14,900
-6.1 m -20'	6.4 m 21'			*7550 *16,700	*7550 *16,700								

*Load is limited by hydraulic capacity rather than tipping. Ratings are based on SAE standard No. J1097. Rated loads do not exceed 87% of hydraulic lift capacity or 75% of tipping load.

PC350LC-8 HYDRAULIC EXCAVATOR

LIFTING CAPACITIES



LIFTING CAPACITY

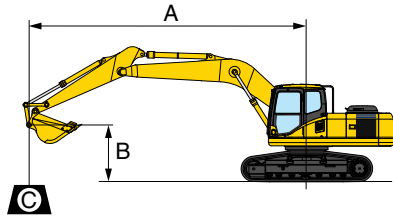

- A: Reach from swing center
- B: Bucket hook height
- C: Lifting capacity
- Cf: Rating over front
- Cs: Rating over side
- ⊗: Rating at maximum reach

Conditions:

- Arm: 4020 mm 13'2"
- Boom length: 6500 mm 21'3"
- Bucket: 1.4 m³ 1.83 yd³ (SAE heaped)
- Bucket weight: 1014 kg 2,235 lb

PC350LC-8		Shoe 700 mm 28"												Unit: kg/lb		
B	A MAX	1.5 m 5'		3.0 m 10'		4.6 m 15'		6.1 m 20'		7.6 m 25'		9.1 m 30'		⊗ MAX		
		Cf	Cs	Cf	Cs	Cf	Cs	Cf	Cs	Cf	Cs	Cf	Cs			
7.6 m 25'	8.8 m 29'														*4150 *9,200	*4150 *9,200
6.1 m 20'	9.6 m 31'											*5850 *12,900	4950 10,900	*4050 *9,000	*4050 *9,000	
4.6 m 15'	10.1 m 33'									*7000 *15,500	6700 14,800	*6450 *14,200	4850 10,700	*4100 *9,100	3950 8,800	
3.0 m 10'	10.4 m 34'					*12600 *27,800	*12600 *27,800	*9450 *20,900	9100 20,100	*7900 *17,400	6350 14,100	*6850 *15,100	4700 10,300	*4300 *9,500	3700 8,100	
1.5 m 5'	10.4 m 34'					*15550 *34,300	13200 29,100	*10950 *24,200	8550 18,800	*8650 *19,100	6050 13,300	7150 15,800	4500 9,900	*4650 *10,200	3550 7,800	
0 m 0'	10.2 m 34'			*6100 *13,400	*6100 *13,400	*16850 *37,200	12400 27,300	*11950 *26,400	8050 17,800	*9250 *20,400	5750 12,700	7000 15,400	4300 9,500	*5150 *11,400	3600 7,900	
-1.5 m -5'	9.8 m 32'	*7000 *15,400	*7000 *15,400	*10000 *22,100	*10000 *22,100	*16900 *37,300	12000 26,500	*12250 *27,000	7800 17,100	9100 20,000	5550 12,300	6900 15,200	4200 9,300	*6000 *13,200	3800 8,400	
-3.0 m -10'	9.1 m 30'	*10100 *22,200	*10100 *22,200	*15900 *35,100	*15900 *35,100	*16050 *35,400	12000 26,400	*11900 *26,200	7700 17,000	9000 19,900	5500 12,200	6850 15,200	4200 9,300	*6950 *15,300	4250 9,400	
-4.6 m -15'	8.0 m 26'	*15200 *33,500	*15200 *33,500	*19500 *43,000	*19500 *43,000	*14100 *31,100	12200 26,900	*10600 *23,300	7800 17,200	*7850 *17,400	5600 12,400			*6950 *15,300	5200 11,400	
-6.1 m -20'	6.4 m 21'			*14000 *30,900	*14000 *30,900	*10550 *23,300	*10550 *23,300	*7650 *16,900	*7650 *16,900					*6450 *14,200	*6450 *14,200	

PC350LC-8		Shoe 800 mm 31.5"												Unit: kg/lb		
B	A MAX	1.5 m 5'		3.0 m 10'		4.6 m 15'		6.1 m 20'		7.6 m 25'		9.1 m 30'		⊗ MAX		
		Cf	Cs	Cf	Cs	Cf	Cs	Cf	Cs	Cf	Cs	Cf	Cs			
7.6 m 25'	8.8 m 29'														*4150 *9,200	*4150 *9,200
6.1 m 20'	9.6 m 31'											*5850 *12,900	5000 11,000	*4050 *9,000	*4050 *9,000	
4.6 m 15'	10.1 m 33'									*7000 *15,500	6750 14,900	*6450 *14,200	4900 10,800	*4100 *9,100	4000 8,900	
3.0 m 10'	10.4 m 34'					*12600 *27,800	*12600 *27,800	*9450 *20,900	9200 20,300	*7900 *17,400	6450 14,200	*6850 *15,100	4750 10,400	*4300 *9,500	3700 8,200	
1.5 m 5'	10.4 m 34'					*15550 *34,300	13350 29,400	*10950 *24,200	8600 19,000	*8650 *19,100	6100 13,400	7250 16,000	4550 10,000	*4650 *10,200	3600 7,900	
0 m 0'	10.2 m 34'			*6100 *13,400	*6100 *13,400	*16850 *37,200	12500 27,600	*11950 *26,400	8150 18,000	*9250 *20,400	5800 12,800	7050 15,600	4350 9,600	*5150 *11,400	3650 8,000	
-1.5 m -5'	9.8 m 32'	*7000 *15,400	*7000 *15,400	*10000 *22,100	*10000 *22,100	*16900 *37,300	12150 26,700	*12250 *27,000	7850 17,300	9200 20,300	5650 12,400	6950 15,400	4250 9,400	*6000 *13,200	3850 8,500	
-3.0 m -10'	9.1 m 30'	*10100 *22,200	*10100 *22,200	*15900 *35,100	*15900 *35,100	*16050 *35,400	12100 26,700	*11900 *26,200	7750 17,100	9100 20,100	5600 12,300	6950 15,300	4250 9,400	*6950 *15,300	4300 9,500	
-4.6 m -15'	8.0 m 26'	*15200 *33,500	*15200 *33,500	*19500 *43,000	*19500 *43,000	*14100 *31,100	12300 27,200	*10600 *23,300	7900 17,400	*7850 *17,400	5650 12,500			*6950 *15,300	5250 11,600	
-6.1 m -20'	6.4 m 21'			*14000 *30,900	*14000 *30,900	*10550 *23,300	*10550 *23,300	*7650 *16,900	*7650 *16,900					*6450 *14,200	*6450 *14,200	

*Load is limited by hydraulic capacity rather than tipping. Ratings are based on SAE standard No. J1097. Rated loads do not exceed 87% of hydraulic lift capacity or 75% of tipping load.



LIFTING CAPACITY

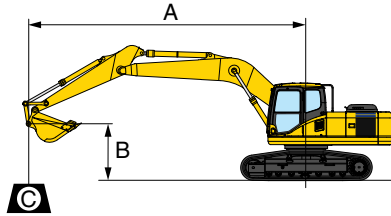

- A: Reach from swing center
- B: Bucket hook height
- C: Lifting capacity
- Cf: Rating over front
- Cs: Rating over side
- ⊗: Rating at maximum reach

Conditions:

- Arm: 4020 mm 13'2"
- Boom length: 6500 mm 21'3"
- Bucket: 1.4 m³ 1.83 yd³ (SAE heaped)
- Bucket weight: 1014 kg 2,235 lb

PC350LC-8		Shoe 850 mm 33.5"												Unit: kg/lb			
B	A	MAX	1.5 m 5'		3.0 m 10'		4.6 m 15'		6.1 m 20'		7.6 m 25'		9.1 m 30'		⊗ MAX		
			Cf	Cs	Cf	Cs	Cf	Cs	Cf	Cs	Cf	Cs	Cf	Cs			
7.6 m 25'	8.8 m 29'														*4150 *9,200	*4150 *9,200	
6.1 m 20'	9.6 m 31'													*5850 *12,900	5050 11,100	*4050 *9,000	*4050 *9,000
4.6 m 15'	10.1 m 33'									*7000 *15,500	6800 15,000	*6450 *14,200	4950 10,900	*4100 *9,100	4050 8,900		
3.0 m 10'	10.4 m 34'					*12600 *27,800	*12600 *27,800	*9450 *20,900	9250 20,400	*7900 *17,400	6450 14,300	*6850 *15,100	4750 10,500	*4300 *9,500	3750 8,300		
1.5 m 5'	10.4 m 34'					*15550 *34,300	13400 29,500	*10950 *24,200	8650 19,100	*8650 *19,100	6150 13,500	*7300 *16,100	4550 10,100	*4650 *10,200	3600 8,000		
0 m 0'	10.2 m 34'			*6100 *13,400	*6100 *13,400	*16850 *37,200	12550 27,700	*11950 *26,400	8200 18,100	*9250 *20,400	5850 12,900	7100 15,700	4400 9,700	*5150 *11,400	3650 8,100		
-1.5 m -5'	9.8 m 32'	*7000 *15,400	*7000 *15,400	*10000 *22,100	*10000 *22,100	*16900 *37,300	12200 26,900	*12250 *27,000	7900 17,400	9250 20,400	5650 12,500	7000 15,400	4300 9,500	*6000 *13,200	3850 8,500		
-3.0 m -10'	9.1 m 30'	*10100 *22,200	*10100 *22,200	*15900 *35,100	*15900 *35,100	*16050 *35,400	12200 26,900	*11900 *26,200	7800 17,200	*9150 *20,100	5600 12,400	*6950 *15,400	4300 9,500	*6950 *15,300	4350 9,500		
-4.6 m -15'	8.0 m 26'	*15200 *33,500	*15200 *33,500	*19500 *43,000	*19500 *43,000	*14100 *31,100	12400 27,300	*10600 *23,300	7900 17,500	*7850 *17,400	5700 12,600			*6950 *15,300	5300 11,600		
-6.1 m -20'	6.4 m 21'			*14000 *30,900	*14000 *30,900	*10550 *23,300	*10550 *23,300	*7650 *16,900	*7650 *16,900					*6450 *14,200	*6450 *14,200		

*Load is limited by hydraulic capacity rather than tipping. Ratings are based on SAE standard No. J1097. Rated loads do not exceed 87% of hydraulic lift capacity or 75% of tipping load.



STANDARD EQUIPMENT

- Alternator, 60 Ampere, 24 V
- AM/FM radio
- Auto-decel
- Automatic air conditioner with defroster
- Automatic engine warm-up system
- Batteries, 2 x 12 V, 150 AH
- Boom and arm holding valves
- Cab, damper mounted
- Counterweight 7371 kg **16,246 lb**
- Dry type air cleaner, double element
- Electric horn
- EMMS monitoring system
- Engine, Komatsu SAA6D114E-3
- Engine overheat prevention system
- Fan guard structure
- Fuel system 10 micron pre-filter
- High pressure in-line hydraulic filters
- Hydraulic track adjusters (each side)
- KOMTRAX®
- Large 7" TFT LCD monitor panel
- Operator Protective Top Guard (OPG), Level 1
- Pattern change valve
- Power maximizing system
- PPC hydraulic control system
- Radiator and oil cooler with net
- Rearview camera (1)
- Rearview mirrors (LH & RH (2 pieces))
- Revolving frame deck guard
- Revolving frame undercovers
- Seat belt, 76 mm **3"** retractable
- Seat, suspension
- Service valve (1 additional)
- Shoes, triple grouser: 800 mm **31.5"**
- Slip resistant foot plates
- Starting motor 11 kW/24V x 1
- Suction fan
- Track guiding guard, center section
- Travel alarm
- Two boom mode settings
- Undercover for track frame center
- Work lights, 2 (boom and RH front)
- Working mode selection system



OPTIONAL EQUIPMENT

- (1) Additional rearview camera, RH side
- Air-ride suspension seat
- Arms
 - 2540 mm **8'4"** arm assembly
 - 3185 mm **10'5"** arm assembly
 - 3185 mm **10'5"** with one actuator piping
 - 4020 mm **13'2"** arm assembly
- Boom
 - 6500 mm **21'3"** HD boom assembly
 - 6500 mm **21'3"** HD with one actuator piping
- Convertor, 12 V
- Full front guard Level 1
- Full front guard Level 2
- One actuator hydraulic control unit
- OPG top guard, Level 2, bolt-on
- Rain visor
- Revolving frame undercovers, heavy duty
- Shoes, triple grouser: 700 mm **28"**
- Shoes, triple grouser: 850 mm **33.5"**
- Straight travel pedal
- Sun visor
- Track frame undercover, heavy duty
- Track roller guards (full length)
- Work light, front, one additional
- Bucket: 2.56 m³ **3.32 yd³** (SAE heaped)



ATTACHMENT OPTIONS

- JRB attachments
 - Couplers
 - Smart-Loc
 - Versa-Loc
 - Vandal protection guards with storage box
 - Komatsu buckets
 - Lincoln autolube systems
 - PSM thumbs
 - Rockland thumbs
- For a complete list of available attachments, please contact your local Komatsu distributor.

KOMATSU®